

Automatic Dampening System NC8.1

Measuring pipe

Pipe diameter 200 mm

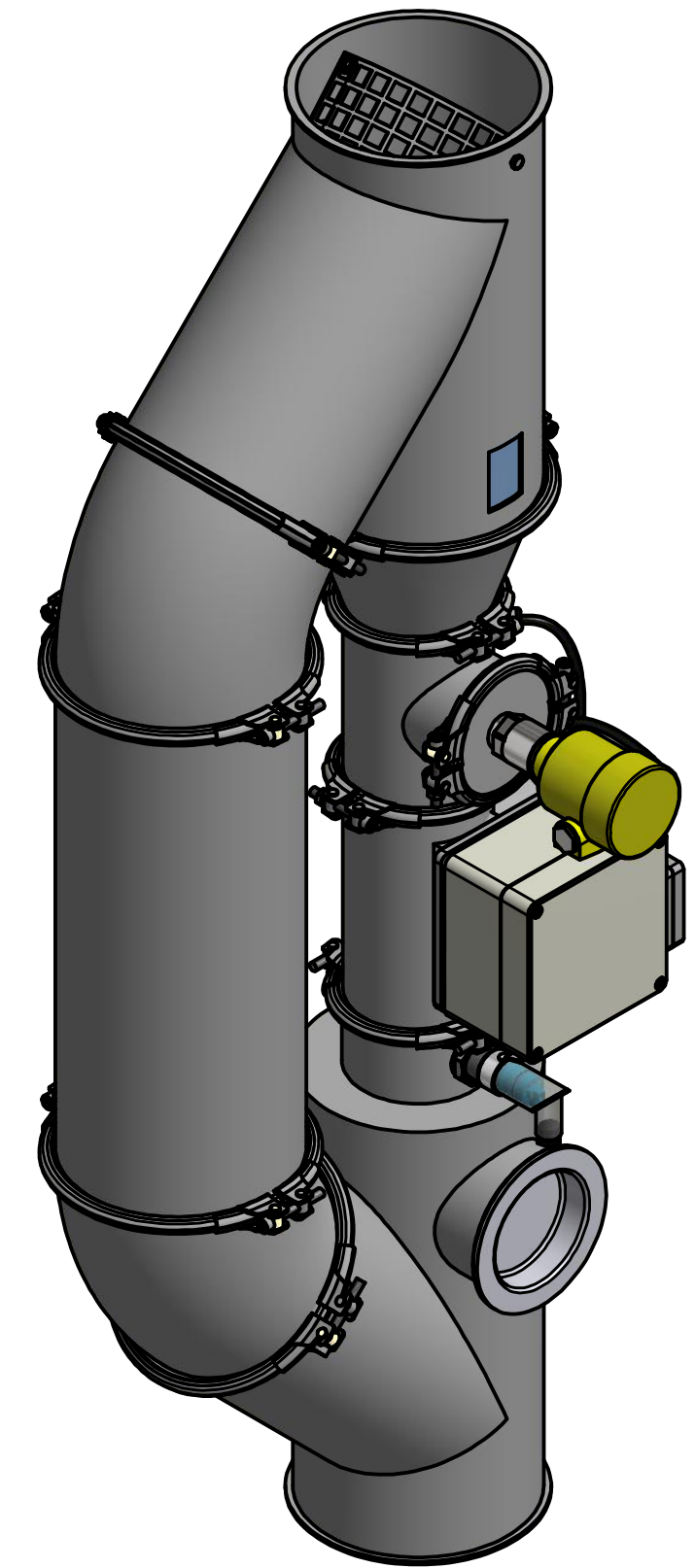
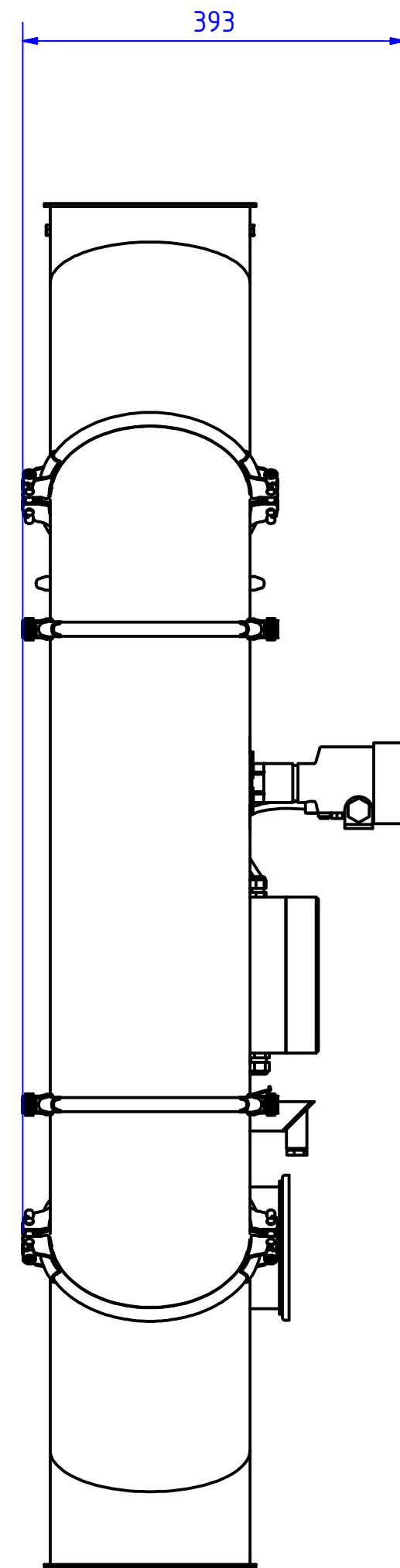
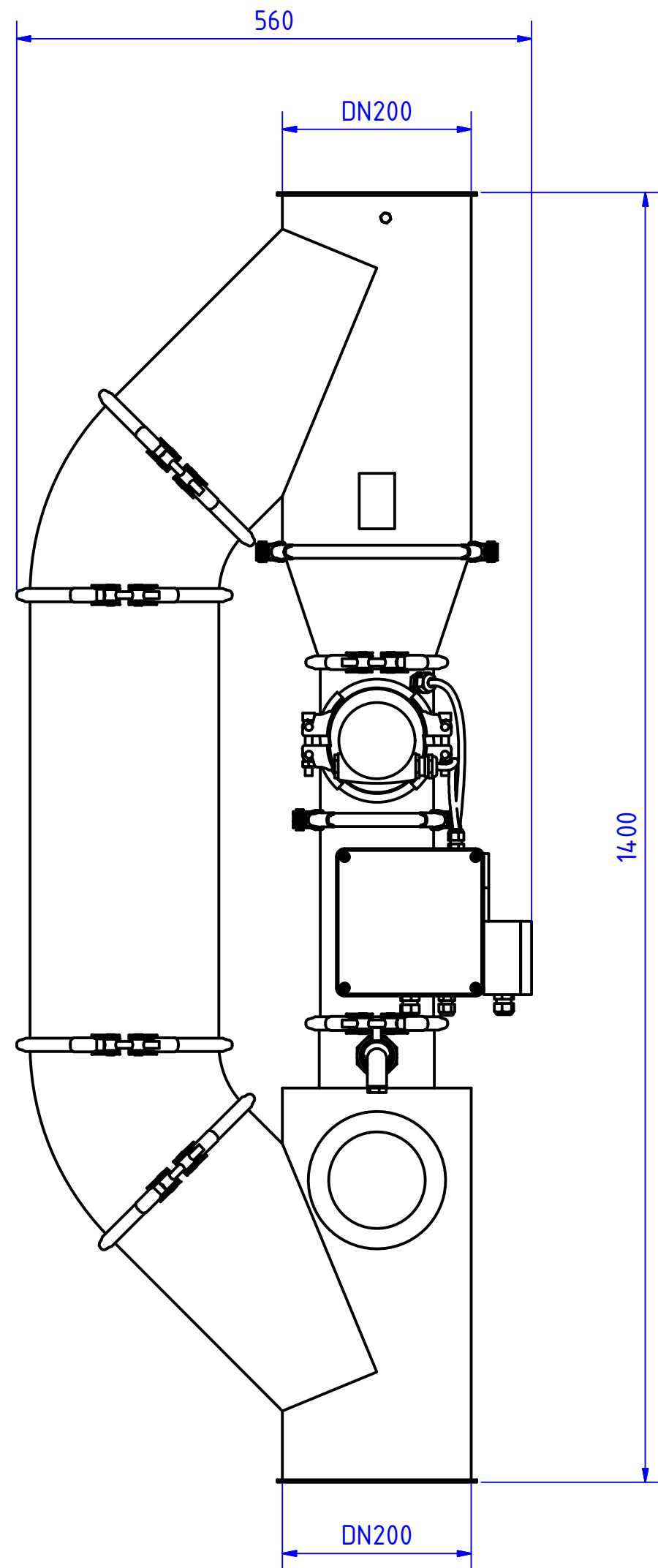

| | | | |
|----------|---|--------|-----|
| Title | Dimensions | | |
| Module | | | |
| Project | | | |
| Page | 1 / 1 | Format | A2 |
| Date | 09.10.2018 | Author | Cem |
| Company | FRIEDRICH electronic GmbH & Co. KG Holzmühlerweg 100, D-35457 Lollar, Germany Tel. +49 (0) 6406 - 1509, Fax. +49 (0) 6406 - 6602 Internet: www.friedrich-electronic.de, Email: service@friedrich-electronic.de | | |
| Filename | | | |